

The High Profile Series™ Straight Baffle ceiling system offers easy ceiling access and versatile, customizable designs for interior commercial applications.

Project: Twin Cities Orthopedics Performance Center, Eagan, MN; High Profile Series™ – Straight Photo credit: Bob Perzel

KEY FEATURES

- Aero Profile
 - 1 5/8" x 6 3/8"
 - Sweep Profile
 - 1 3/4" x 6 3/8"
 - Beam Profile
 - 1 1/2" x 4 3/8"
 - 1 1/2" x 6 3/8"
 - 1 1/2" x 8 3/8"
 - 2" x 4"
 - 2" x 6"
 - 2" x 8"
 - 4" x 4"
 - Beam - Open
 - 4" x 4"
 - Taper
 - 1 1/2" x 8"
 - Crescent
 - 4" x 6 3/8"
- Note: Client specific shapes and finishes available
- Extruded aluminum profiles with exacting fit and finish
 - Seamless baffles up to 20 feet in length
 - Unistrut® support system
 - Baffles can be collapsible along Unistrut® for easy accessibility
 - Client-specific suspension systems
 - Patented locking mechanism

TYPICAL ISOMETRICS

Standard profiles shown for illustrative purposes only.
Client-specific profiles available – contact manufacturer

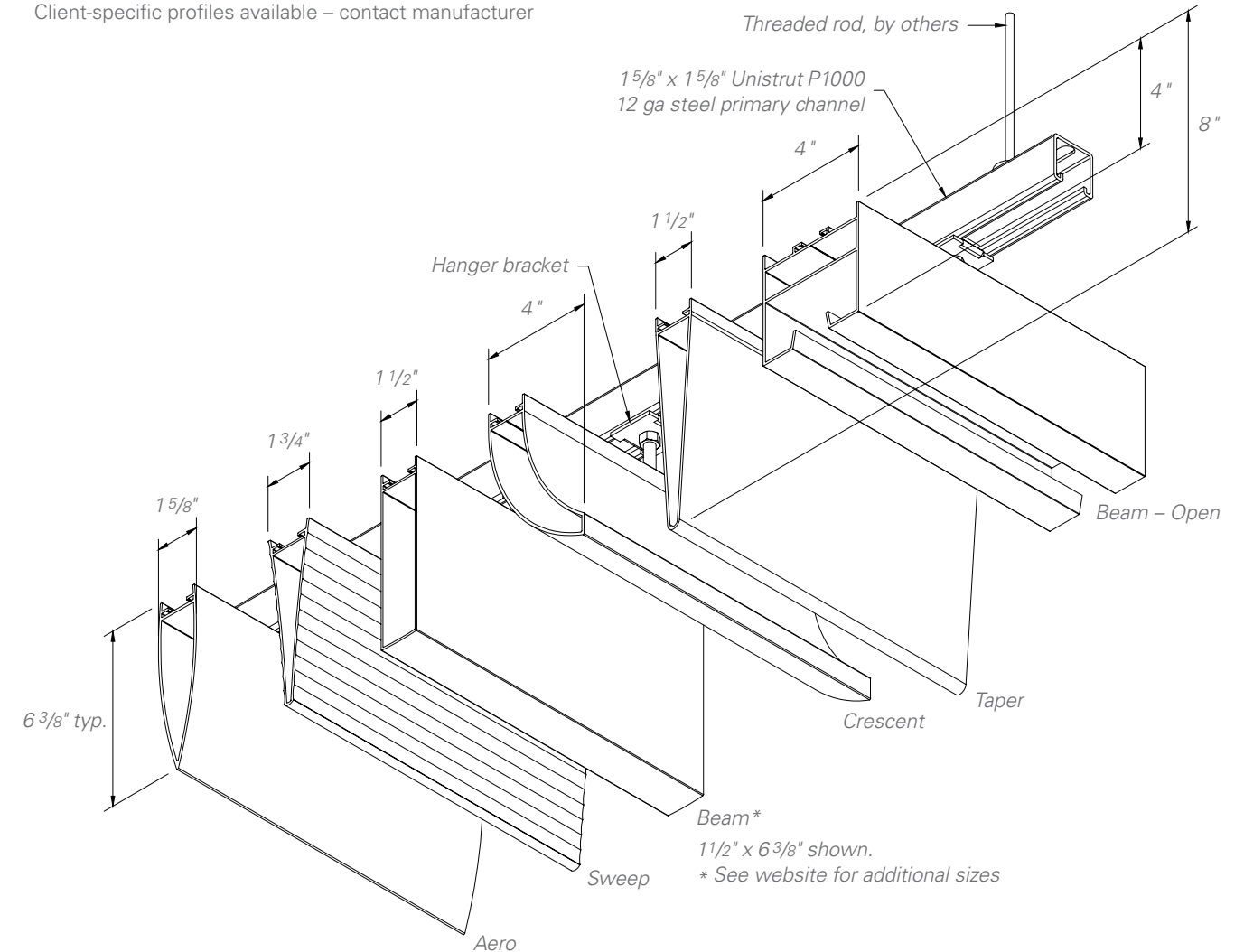

PHYSICAL DATA

Substrate: Aluminum
Warranty: 1 year
Seismic rating: Zones A,B,C,D,E,F
Fire rating: Class A Fire Rated per ASTM E84
 – Painted or anodized metal: Flame spread: ≤ 25, Smoke ≤ 50
 – Wood veneer on metal: Flame spread: ≤ 25, Smoke ≤ 55 (for interior applications)
Weight: Varies 2.0 – 4.0 lbs./sq.ft.
Wind load: N/A
Recycled content: Up to 50%
Light reflectance (LR) Coefficient per ASTM E1264 & ASTM E1477:
 – Cotton White: LR = 0.81

BIM

REVIT files available for BIM contributions, see website for details.

LEED V4 CREDITS

MR: Building Product Disclosure
EQ: Low-Emitting Materials
EQ: Indoor Air Quality Assessment

CERTIFICATIONS

GREENGUARD Gold Certified
 EPDs – available upon request

METAL CEILINGS

BEAMS & BAFFLES
HIGH PROFILE SERIES™ – STRAIGHT

COLORS & FINISHES

A wide choice of colors and finishes are available and some carry a premium price over manufacturer's standard colors. Custom color matching is available upon request. Minimum quantities and lead times may apply. See website for the most up to date information and to order samples. Colors are for illustration purposes only.

STANDARD PAINT COLORS



CUSTOM COLORS

Premium custom colors.



WHITE FINISH OPTIONS

Powder-coat paint finish for Arctic White #1015P (Gloss 10-20); Crystalline White #1050P (Gloss 45-55); Supernova White #1085P (Gloss 80-90)

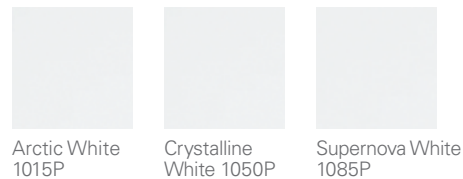

DAYLIGHTING WHITE PAINT FINISH

Powder-coat paint finish offering LRV 96; non-glare, 3% low gloss finish. Certified by: Applied Technical Services, Inc. Test Report No. D233185. Test reports available by request.

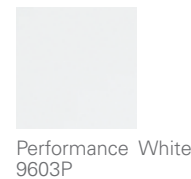

BLACK FINISH OPTIONS

Powder-coat paint finish for Starless Black #5000P (Matte); Raven Black #5030P (Gloss 25-35); Sable Black #5060P (Gloss 65-75); Wet Glass Black #5095P (Gloss 90-95)



Wilsonart®

This collection features finishes (interior only) that coordinate easily with the other materials you specify. No minimum. Please contact manufacturer for client-specific species and stains.



STANDARD WOOD VENEER OPTIONS

Real wood veneer (interior only). Formaldehyde-free, Class A composite panel. Note: This is a small subset of veneers available. Please contact manufacturer for client-specific species and stains.

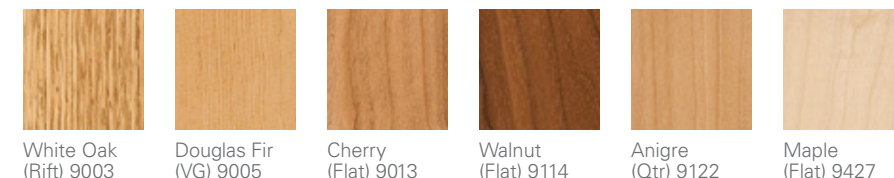

DECORATED WOOD-LOOK OPTIONS

Powder-coat paint finish (interior and exterior). Formaldehyde-free, Class A composite panel. This finish is recommended for exterior conditions.



DECORATED MASONRY OPTIONS

Powder-coat paint finish (interior and exterior). Formaldehyde-free, Class A composite panel. This finish is recommended for exterior conditions.

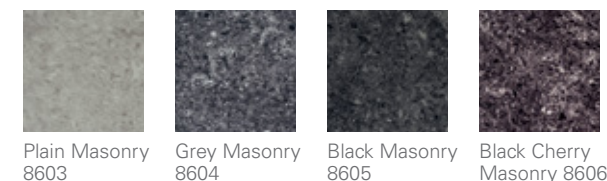

METAL
CEILINGSBEAMS & BAFFLES
HIGH PROFILE SERIES™ – FRAMEWORKS

The High Profile Series™ Frameworks ceiling system offers versatile, customizable designs for interior commercial applications.

Project: Accenture Atlanta, Atlanta, GA; High Profile Series™ – Frameworks Photo credit: Studio 66 LLC

KEY FEATURES

- Beam Profile
 - 1 1/2" x 4 3/8"
 - 1 1/2" x 6 3/8"
 - 1 1/2" x 8 3/8"
 - 2" x 4"
 - 2" x 6"
 - 2" x 8"
 - 4" x 4"
- Extruded aluminum beam configurations can be customized to create one-off ceiling designs
- Precision-cut straight and curved elements to create peaks, valleys, angles, walls & screens
- Seamless baffles up to 20 feet in length
- Integrated lighting options
- Versatile support options include threaded rods, Unistrut® support system or aircraft cables for lower visibility
- Patented locking mechanism

Note: Client specific shapes and finishes available

TYPICAL ISOMETRICS

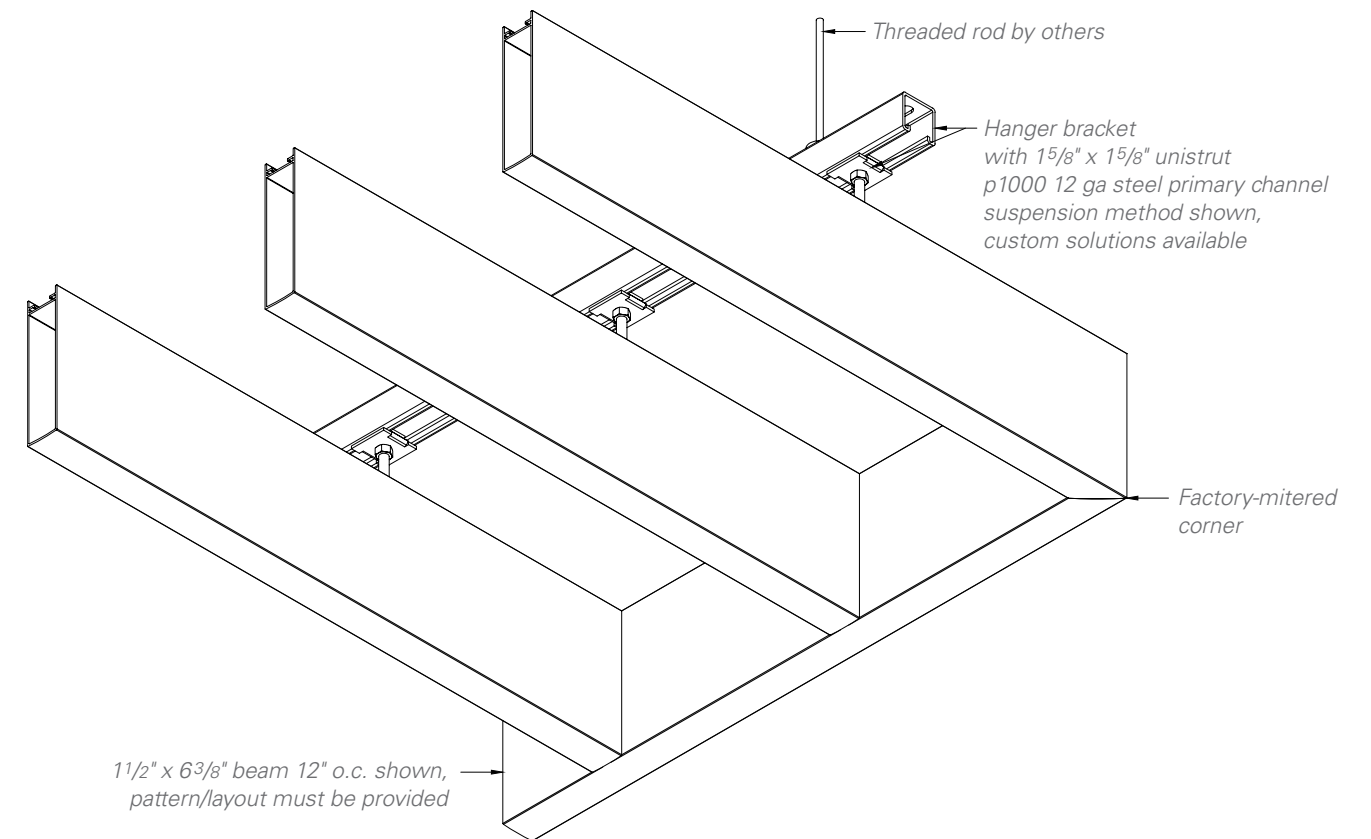

PHYSICAL DATA

Substrate: Aluminum
Warranty: 1 year
Seismic rating: Zones A,B,C,D,E,F
Fire rating: Class A Fire Rated per ASTM E84
 – Painted or anodized metal: Flame spread: ≤ 25, Smoke ≤ 50
 – Wood veneer on metal: Flame spread: ≤ 25, Smoke ≤ 55 (for interior applications)
Weight: Varies 2.0 – 4.0 lbs./sq.ft.
Wind load: N/A
Recycled content: Up to 50%
Light reflectance (LR) Coefficient per ASTM E1264 & ASTM E1477:
 – Cotton White: LR = 0.81

BIM

REVIT files available for BIM contributions, see website for details.

LEED V4 CREDITS

MR: Building Product Disclosure
EQ: Low-Emitting Materials
EQ: Indoor Air Quality Assessment

CERTIFICATIONS

GREENGUARD Gold Certified
 EPDs – available upon request

METAL CEILINGS

BEAMS & BAFFLES
HIGH PROFILE SERIES™ – FRAMEWORKS

COLORS & FINISHES

A wide choice of colors and finishes are available and some carry a premium price over manufacturer's standard colors. Custom color matching is available upon request. Minimum quantities and lead times may apply. See website for the most up to date information and to order samples. Colors are for illustration purposes only.

STANDARD PAINT COLORS



CUSTOM COLORS

Premium custom colors.

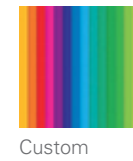

WHITE FINISH OPTIONS

Powder-coat paint finish for Arctic White #1015P (Gloss 10-20); Crystalline White #1050P (Gloss 45-55); Supernova White #1085P (Gloss 80-90)

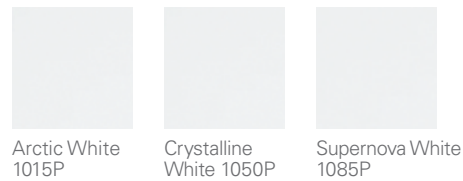

DAYLIGHTING WHITE PAINT FINISH

Powder-coat paint finish offering LRV 96; non-glare, 3% low gloss finish. Certified by: Applied Technical Services, Inc. Test Report No. D233185. Test reports available by request.

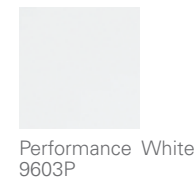

BLACK FINISH OPTIONS

Powder-coat paint finish for Starless Black #5000P (Matte); Raven Black #5030P (Gloss 25-35); Sable Black #5060P (Gloss 65-75); Wet Glass Black #5095P (Gloss 90-95)

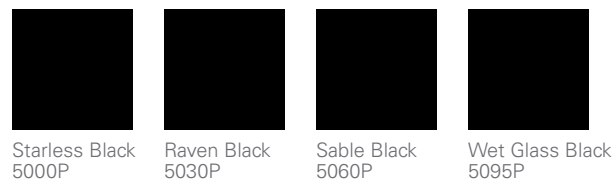

Wilsonart®

This collection features finishes (interior only) that coordinate easily with the other materials you specify. No minimum. Please contact manufacturer for client-specific species and stains.

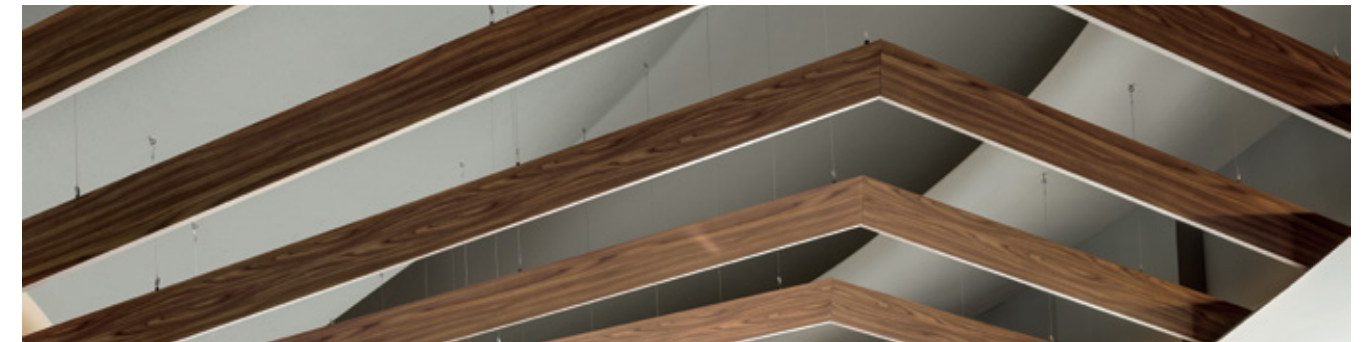

STANDARD WOOD VENEER OPTIONS

Real wood veneer (interior only). Formaldehyde-free, Class A composite panel. Note: This is a small subset of veneers available. Please contact manufacturer for client-specific species and stains.

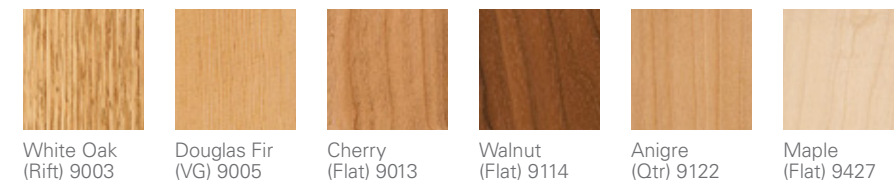

DECORATED WOOD-LOOK OPTIONS

Powder-coat paint finish (interior and exterior). Formaldehyde-free, Class A composite panel. This finish is recommended for exterior conditions.



DECORATED MASONRY OPTIONS

Powder-coat paint finish (interior and exterior). Formaldehyde-free, Class A composite panel. This finish is recommended for exterior conditions.



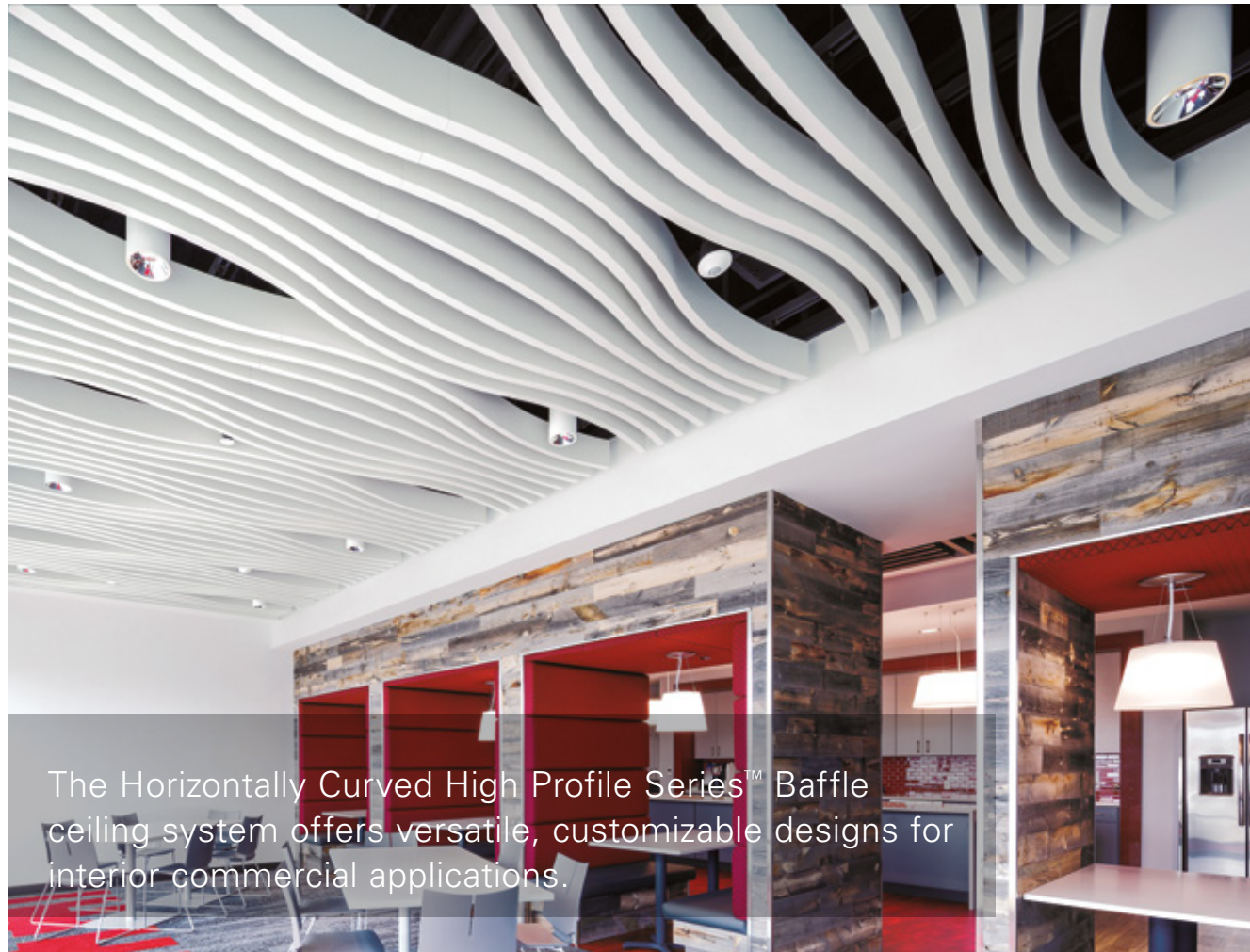

The Horizontally Curved High Profile Series™ Baffle ceiling system offers versatile, customizable designs for interior commercial applications.

Project: Corporate Learning & Development Center, Fort Mill, SC; High Profile Series™ – Horizontally Curved Photo credit: Studio 66 LLC

KEY FEATURES

- Beam Sizes
 - Aero Profile
1-5/8" x 6-3/8"
 - Beam Profile
1-1/2" x 4-3/8"
1-1/2" x 6-3/8"
1-1/2" x 8-3/8"
2" x 4"
2" x 6"
2" x 8"
4" x 4"
 - Beam – Open
4" x 4"
- Extruded aluminum profiles with exacting fit and finish
- Minimum radius 48"
- Seamless baffles with arc lengths 4 to 20 feet
- Unistrut® support system
- Client-specific suspension systems
- Patented locking mechanism

Note: Client specific shapes and finishes available

TYPICAL ISOMETRICS

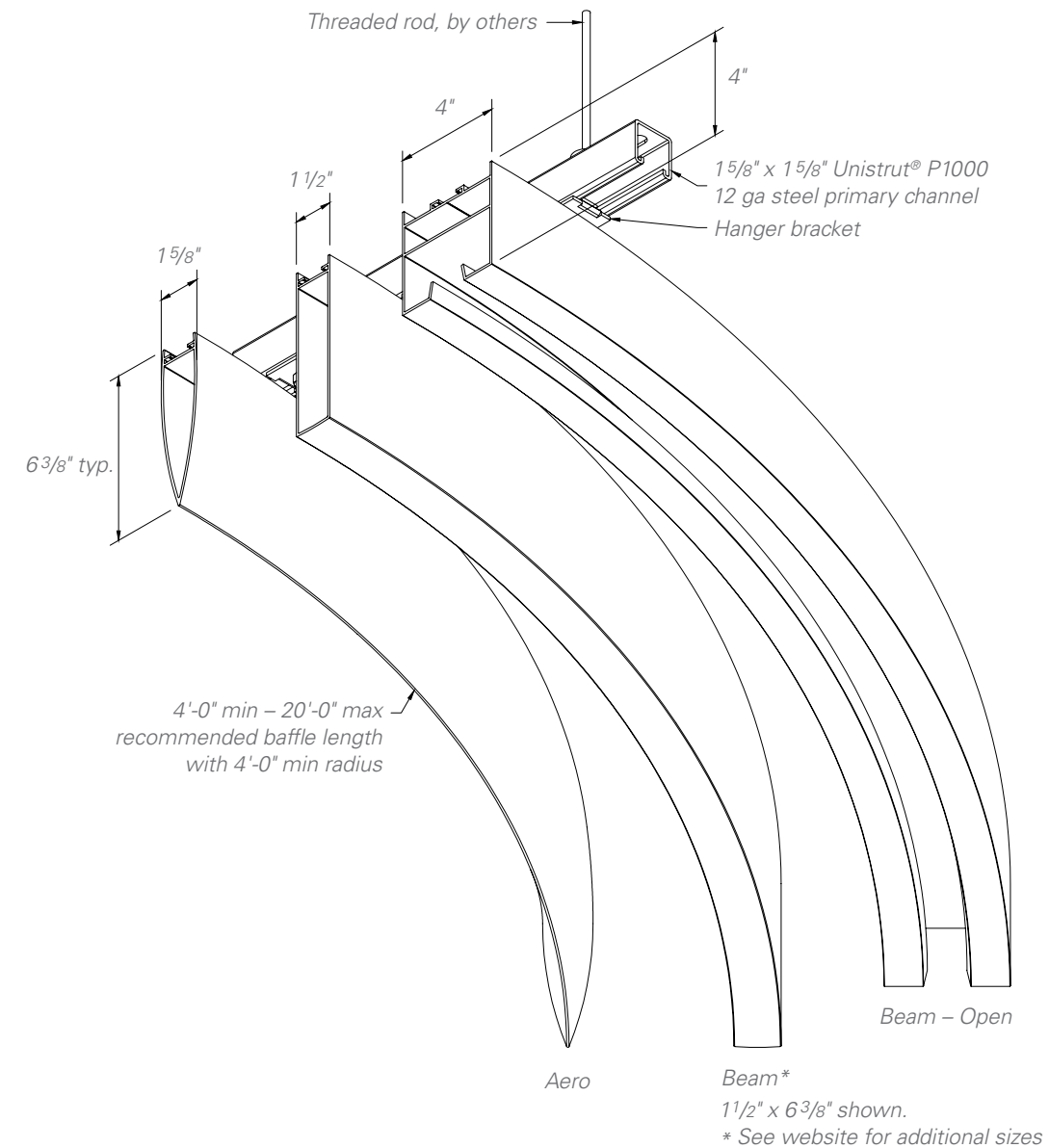

PHYSICAL DATA

Substrate: Aluminum
Warranty: 1 year
Seismic rating: Zones A,B,C,D,E,F
Fire rating: Class A Fire Rated per ASTM E84
 – Painted or anodized metal: Flame spread: ≤ 25, Smoke ≤ 50
Weight: Varies 2.0 – 4.0 lbs./sq.ft.
Wind load: N/A
Recycled content: Up to 50%
Light reflectance (LR) Coefficient per ASTM E1264 & ASTM E1477:
 – Cotton White: LR = 0.81

BIM

REVIT files available for BIM contributions, see website for details.

LEED V4 CREDITS

MR: Building Product Disclosure
EQ: Low-Emitting Materials
EQ: Indoor Air Quality Assessment

CERTIFICATIONS

GREENGUARD Gold Certified
 EPDs – available upon request

METAL CEILINGS

BEAMS & BAFFLES
HIGH PROFILE SERIES™ – HORIZONTALLY CURVED

COLORS & FINISHES

A wide choice of colors and finishes are available and some carry a premium price over manufacturer's standard colors. Custom color matching is available upon request. Minimum quantities and lead times may apply. See website for the most up to date information and to order samples. Colors are for illustration purposes only.

STANDARD PAINT COLORS



Natural
7163



Cotton White
0280

WHITE FINISH OPTIONS

Powder-coat paint finish for Arctic White #1015P (Gloss 10-20); Crystalline White #1050P (Gloss 45-55); Supernova White #1085P (Gloss 80-90)

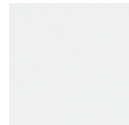

Arctic White
1015P

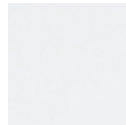

Crystalline White
1050P

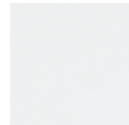

Supernova White
1085P

CUSTOM COLORS

Premium custom colors.



Custom

DAYLIGHTING WHITE PAINT FINISH

Powder-coat paint finish offering LRV 96; non-glare, 3% low gloss finish. Certified by: Applied Technical Services, Inc. Test Report No. D233185. Test reports available by request.

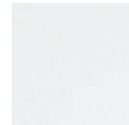

Performance White
9603P

BLACK FINISH OPTIONS

Powder-coat paint finish for Starless Black #5000P (Matte); Raven Black #5030P (Gloss 25-35); Sable Black #5060P (Gloss 65-75); Wet Glass Black #5095P (Gloss 90-95)



Starless Black
5000P



Raven Black
5030P



Sable Black
5060P



Wet Glass Black
5095P

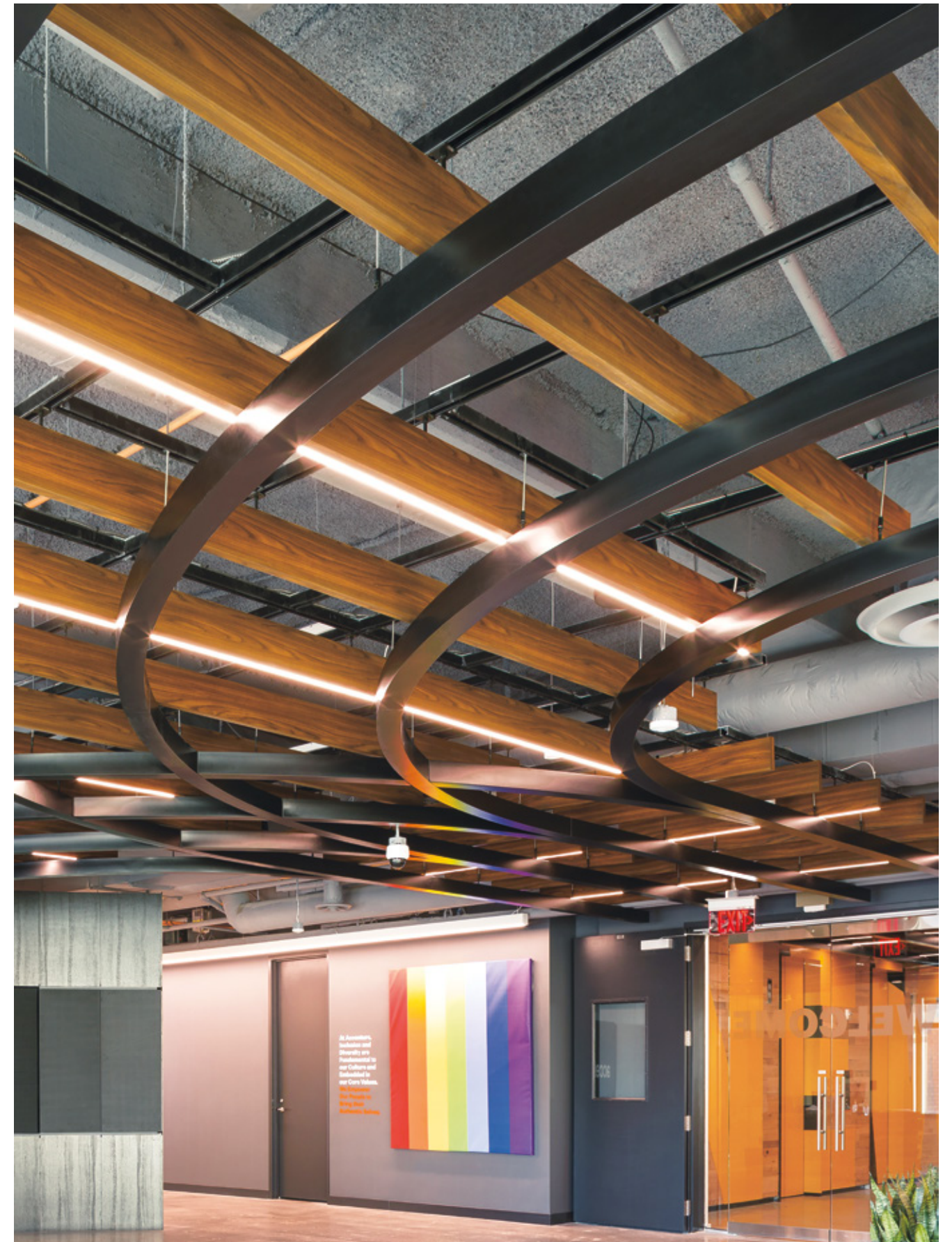

Project: Accenture Atlanta, Atlanta, GA; High Profile Series™ – Horizontally Curved Photo credit: Studio 66 LLC

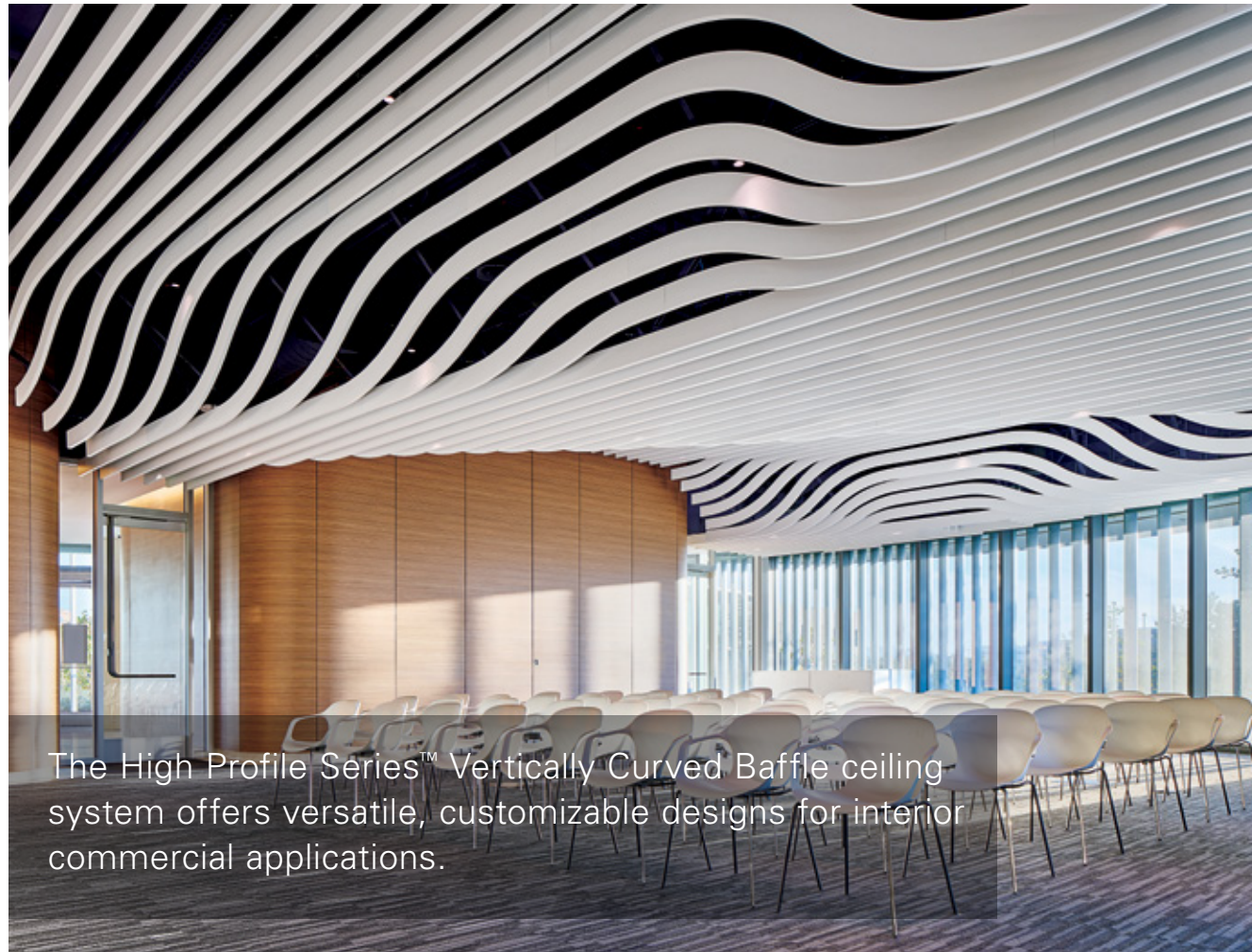

The High Profile Series™ Vertically Curved Baffle ceiling system offers versatile, customizable designs for interior commercial applications.

Project: Jacobs Medical Center, UC San Diego Health, CA; High Profile Series™ – Vertically Curved Photo credit: Christopher Barrett

KEY FEATURES

- Standard profile: 1 1/2" x 6 3/8" Beam
- Extruded aluminum profiles with exacting fit and finish
- Minimum radius 48"
- Seamless baffles with arc lengths 4 to 20 feet
- Unistrut® support system
- Client-specific suspension systems
- Patented locking mechanism
- Strength to support signage

TYPICAL ISOMETRICS

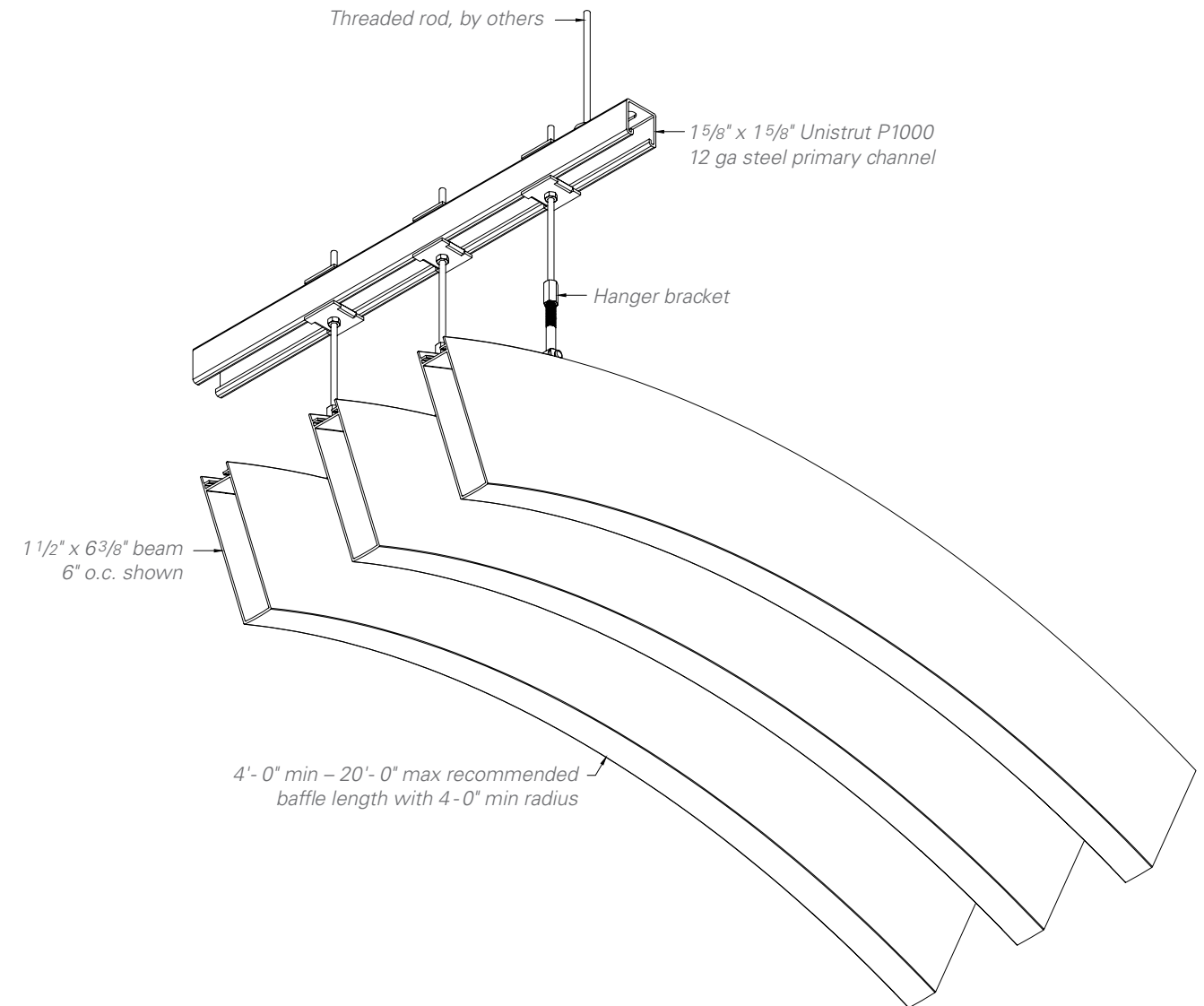

PHYSICAL DATA

Substrate: Aluminum
Warranty: 1 year
Seismic rating: Zones A,B,C,D,E,F
Fire rating: Class A Fire Rated per ASTM E84
 – Painted or anodized metal: Flame spread: ≤ 25, Smoke ≤ 50
Weight: Varies 2.0 – 4.0 lbs./sq.ft.
Wind load: N/A
Recycled content: Up to 50%
Light reflectance (LR) Coefficient per ASTM E1264 & ASTM E1477:
 – Cotton White: LR = 0.81

BIM

REVIT files available for BIM contributions,
see website for details.

LEED V4 CREDITS

MR: Building Product Disclosure
EQ: Low-Emitting Materials
EQ: Indoor Air Quality Assessment

CERTIFICATIONS

GREENGUARD Gold Certified
 EPDs – available upon request

METAL CEILINGS

BEAMS & BAFFLES
HIGH PROFILE SERIES™ – VERTICALLY CURVED

COLORS & FINISHES

A wide choice of colors and finishes are available and some carry a premium price over manufacturer's standard colors. Custom color matching is available upon request. Minimum quantities and lead times may apply. See website for the most up to date information and to order samples. Colors are for illustration purposes only.

STANDARD PAINT COLORS



Natural
7163



Cotton White
0280

CUSTOM COLORS

Premium custom colors.



Custom

WHITE FINISH OPTIONS

Powder-coat paint finish for Arctic White #1015P (Gloss 10-20); Crystalline White #1050P (Gloss 45-55); Supernova White #1085P (Gloss 80-90)

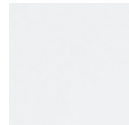

Arctic White
1015P

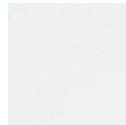

Crystalline White
1050P

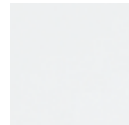

Supernova White
1085P

DAYLIGHTING WHITE PAINT FINISH

Powder-coat paint finish offering LRV 96; non-glare, 3% low gloss finish. Certified by: Applied Technical Services, Inc. Test Report No. D233185. Test reports available by request.

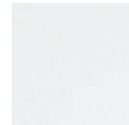

Performance White
9603P

BLACK FINISH OPTIONS

Powder-coat paint finish for Starless Black #5000P (Matte); Raven Black #5030P (Gloss 25-35); Sable Black #5060P (Gloss 65-75); Wet Glass Black #5095P (Gloss 90-95)



Starless Black
5000P



Raven Black
5030P



Sable Black
5060P



Wet Glass Black
5095P

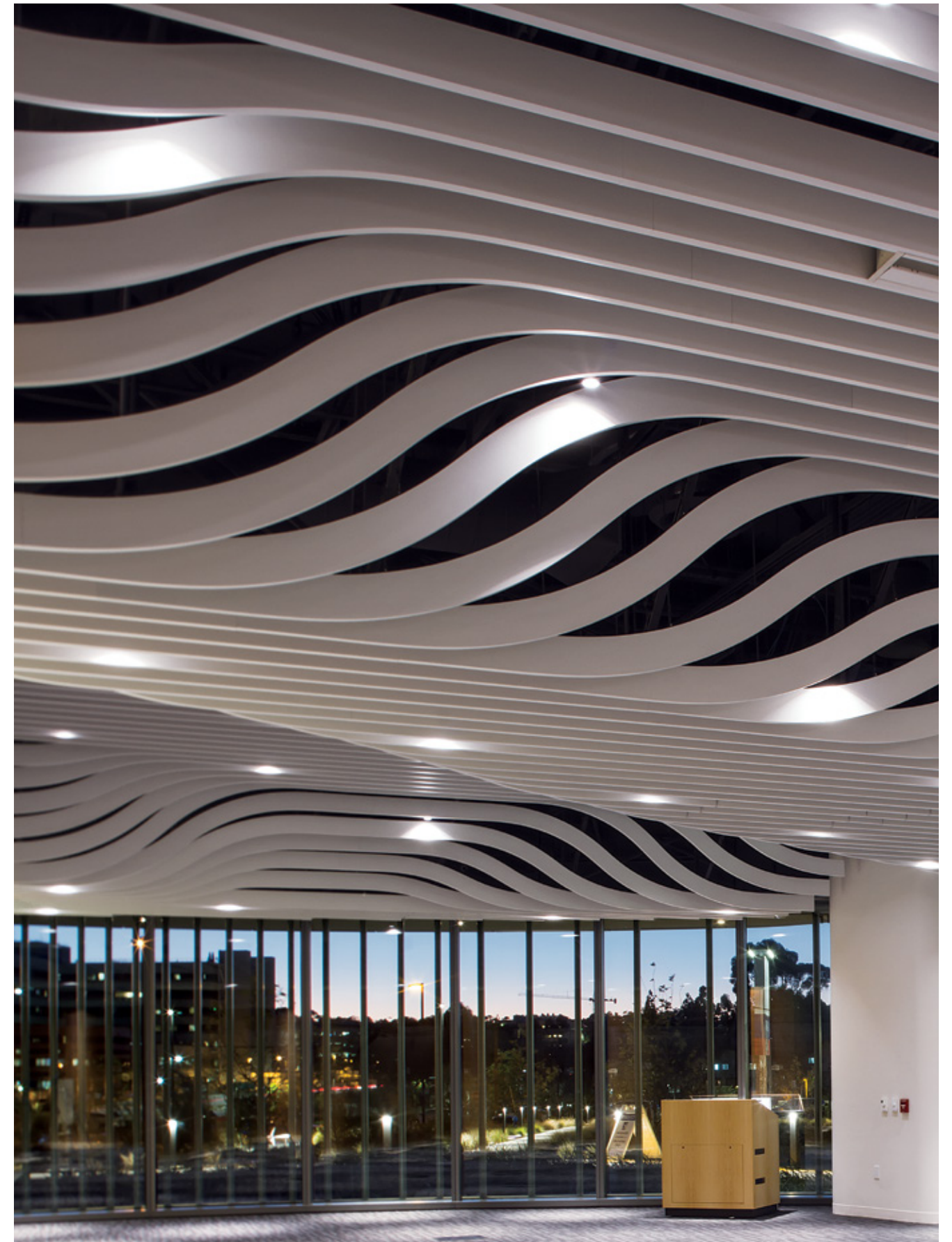

Project: Jacobs Medical Center, UC San Diego Health, CA; High Profile Series™ – Vertically Curved Photo credit: Taube Photography