

Add layers and depth by combining panels of varying heights to the ceiling plane with HeartFelt™ Levels.

KEY FEATURES

- Modular ceiling system with felt panels
- Panel Width: 1⁹/₁₆"
- Panel: Depth: 2³/₁₆"
- Panel length: 8'
- Panel depth reveal: Up to 1"
- Varying heights and spaces allow for enhanced acoustics and unique custom visuals in a modular application
- Square-edge design
- Easy plenum access
- Interior applications
- Compatible with industry standard lighting, HVAC, speaker, fire safety, and security services
- Red Dot Award 2017 Winner - Best of the Best
- Carrier modules for various depths and reveals

TYPICAL SECTION

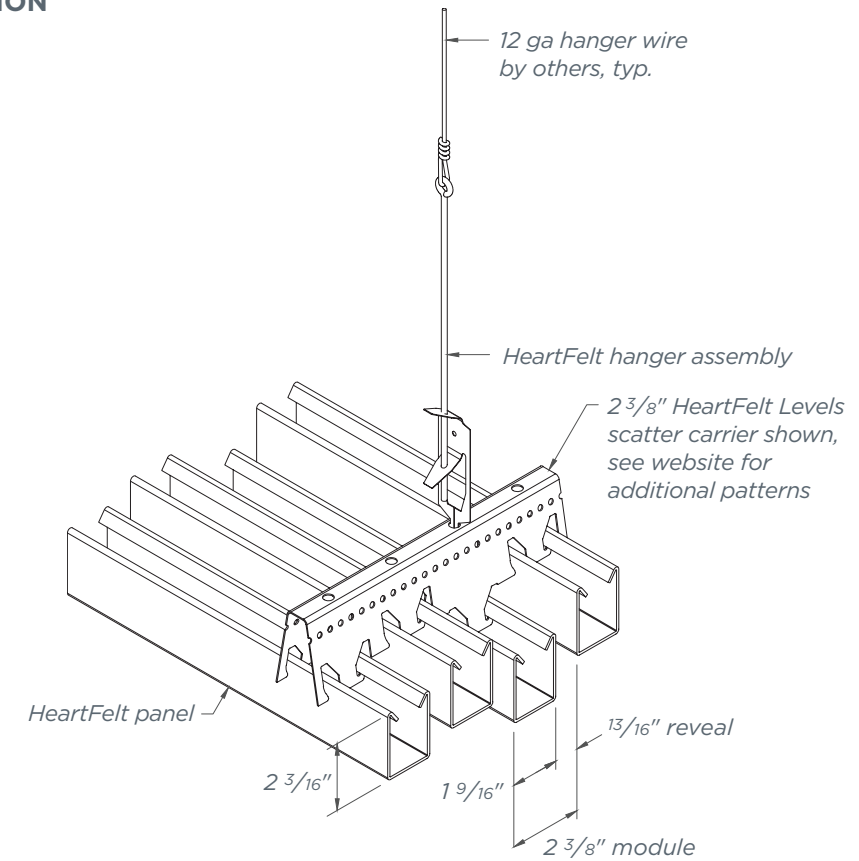

CONFIGURATIONS SUGGESTED

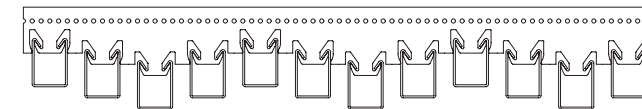

WAVE

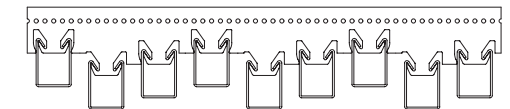

CHOPPY

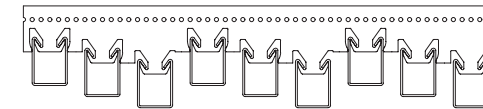

STEP

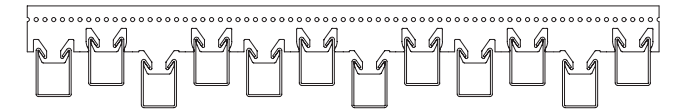

SCATTER

PHYSICAL DATA

Substrate: Non-woven PES fibers (felt)
Warranty: 1 year
Seismic rating: Zones A,B,C,D,E,F
Fire rating: Class A Fire Rated per ASTM E84
 - Flame spread: ≤ 25, Smoke ≤ 300
Fire rating: Canada - per CAN/ULC S102.2-10
 - Flame spread: = 5, Smoke = 90
Weight: Varies
Wind load: N/A
Light reflectance: Varies with color selected
Acoustical ratings - NRC: See Resources section.

LEED V4 CREDITS

MR: Building Product Disclosure
EQ: Low-Emitting Materials
EQ: Indoor Air Quality Assessment
EQ: Acoustic Performance

CERTIFICATIONS

GREENGUARD Gold Certified
 Cradle-to-Cradle Bronze Certified
 Material Health Certified - Bronze

HEARTFELT™

HEARTFELT™ LEVELS - FELT CEILINGS

COLORS & FINISHES

Please contact manufacturer for minimum quantities and lead times. See website for the most up to date information or to request samples. Colors are for illustration purposes only.

COLORS

HeartFelt - Greys

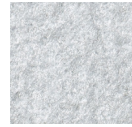
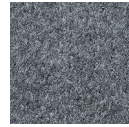
White
7593FLight Grey
7596FMiddle Grey
7597FDark Grey
7598FBlack
7594F

HeartFelt - Earth Tones

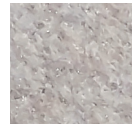
Creme
7575FLight Brown
7576FMiddle Brown
7577FDark Brown
7578FUmber
7579F

Given the unique and special nature of our HeartFelt™ ceiling product, steps should be taken (before and during installation, as well as over the lifetime of the ceiling) to avoid or minimize static and the accumulation of dust, lint, dirt or airborne particles on or around the felt. Manufacturer does not warrant against or take responsibility for any such static or accumulation.

